

P5-16...R40-17

Model: E01

en Assembly and Operating Instructions

Tubular drives for roller shutters

Important information for:

- Fitters / • Electricians / • Users

Please forward accordingly!

These instructions must be kept safe for future reference.

2010 300 624 0g 15/02/2024

Becker-Antriebe GmbH
Friedrich-Ebert-Straße 2-4
35764 Sinn/Germany
info@becker-antriebe.com
www.becker-antriebe.com



BECKER
for you. forever.

Table of contents

General	3
Warranty	3
Safety instructions	4
Instructions for the user	4
Instructions for installation and commissioning	4
Intended use	6
Assembling and disassembling the plug-in connecting cable	6
Assembly	7
Setting the limit positions with the switches on the drive head	10
Deleting the limit positions using the switches	12
Setting the limit positions using the programming unit	13
Deleting the limit positions using the programming unit	16
Adjusting the limit positions with a rotary switch or a locking button	17
Deleting the limit positions with a rotary switch or a locking button	19
Additional upper anti-freeze mechanism	20
Obstacle detection	20
Fly screen protection function	21
Information for the electrician	21
Torque detection	21
Disposal	21
Maintenance	21
Technical data dia. 35	22
Technical data dia. 45	22
What to do if...?	23
Sample wiring diagrams	24
Declaration of conformity	25

General

These tubular drives are high-quality products with the following features:

- Optimised for roller shutter operation
- Installation without stops possible (from lower point to upper point)
- Automatic detection of the lower limit position when using springs in conjunction with the "drive adapter for obstacle detection"
- Automatic detection of limit positions thanks to intelligent electronic system with stop systems
- Obstacle detection, even when using rigid shaft connectors (axle shaft devices)
- Slight pressure applied to the roller shutter curtain makes it difficult to raise or reach under it
- Suitable for rigid aluminium, steel and wooden profiles
- Torque control in the up direction prevents damage to the roller shutter in the event of a frozen or blocked shutter
- The limit positions do not have to be reset: Changes in the shading solution are accommodated automatically when using stop systems.
- Drive puts the roller shutter curtain under low tensile load
- Considerably reduced stop load, and thus considerably reduced shading solution load
- Several drives can be operated in parallel
- Compatible with existing drives with electronic limit switching (4-core connecting cable)
- Compatible with the comprehensive range of the drive manufacturer's control units
- For plug-in connecting cable

Please follow these Assembly and Operating Instructions when installing and setting up the device.



The date of manufacture comes from the first four digits of the serial number.

The numbers 1 and 2 indicate the year and the numbers 3 and 4 indicate the calendar week.

Example: 34th calendar week in 2020

Ser. No.:	2034XXXXX
-----------	-----------

Explanation of pictograms

	CAUTION	CAUTION indicates a hazardous situation which, if not avoided, could result in injury.
	ATTENTION	ATTENTION indicates measures that must be taken to avoid damage to property.
		Denotes user tips and other useful information.

Warranty

Structural modifications and incorrect installation which are not in accordance with these and our other instructions can result in serious injuries, e.g., crushing of limbs. Therefore, structural modifications may only be carried out with our prior approval and strictly in accordance with our instructions, particularly the information contained in these Assembly and Operating Instructions. Any further processing of the products which does not comply with their intended use is not permitted.

The end product manufacturer and fitter have to ensure that all the relevant current statutory, official and, in particular, EMC regulations are adhered to during utilisation of our products, especially with regard to end product manufacture, installation and customer advice.

Safety instructions

The following safety instructions and warnings are intended to avert hazards and to prevent property damage and personal injury.

Instructions for the user

General information

- The drive must be disconnected from its power source during cleaning and maintenance and when replacing parts.
- All work, including maintenance and cleaning, on electrical installations as well as other system parts must always be performed by trained technicians, in particular qualified electricians.
- Children from the age of 8 years and persons with reduced physical, sensory or mental capabilities or lack of experience and/or knowledge may use these devices, provided they are supervised or have been instructed in the safe use of the device, and have understood the hazards involved. Children must not play with the device.
- Systems have to be checked regularly by authorised specialists for wear and damage.
- Always put damaged systems out of operation immediately until they are repaired by an authorised specialist.
- Do not operate equipment if people or objects are within the danger zone.
- Observe the danger zone of the equipment during operation.
- Ensure that there is adequate clearance (at least 40 cm) between moving parts and adjacent objects.



Caution

Safety instructions for avoiding serious injuries.

- **Crushing or shearing points must be avoided or protected.**

Instructions for installation and commissioning

General information

- Observe the safety instructions in EN 60335-2-97. Please note that this list of safety instructions is not exhaustive, since it would be impossible for the standard to include all sources of danger. For example, the design of the operated product, the way the drive works in the situation it is installed in or even the way the end product is mounted in the end user's place of use cannot be taken into consideration by the drive manufacturer.
If any questions or uncertainties regarding the safety instructions contained in the standard arise, please contact the manufacturer of the part or end product in question.
- All applicable standards and regulations for electrical installation must be complied with.
- All work, including maintenance and cleaning, on electrical installations as well as other system parts must always be performed by trained technicians, in particular qualified electricians.
- Only use spare parts, tools and accessory devices which have been approved by the drive manufacturer.
Unapproved third-party products or modifications to the system and its accessories represent a risk to your safety and the safety of others. This means that the use of unapproved third-party products, or modifications which have not been agreed with or approved by us, are prohibited. We do not accept liability for damage or injury arising from such actions.
- Position switch with OFF presetting within sight of the driven product, but away from moving parts, at a height of over 1.5 m. This must not be publicly accessible.
- Permanently mounted control devices must be positioned where they can be seen.
- Rated torque and duty cycle must be suitable for the requirements of the driven product.
Technical data - rated torque and service life can be found on the type plate of the tubular drive.
- Hazardous moving parts of the drive must be installed at a height of over 2.5 m above floor level or any other surface from which the drive can be accessed.
- To ensure safe operation of the system after commissioning, the limit positions must be correctly set/programmed in.
- Drives with a H05VV-F connecting cable may only be used indoors.
- Drives with a H05RR-F, S05RN-F or 05RN-F connecting cable may be used both indoors and outdoors.
- To connect the drive to the driven part, solely mechanical accessory components made by the drive manufacturer from the current product catalogue may be used. The components must be installed in accordance with the manufacturer's instructions.

- If the drive is used for shading solutions in a specially marked area (e.g., escape routes, hazard zones, safety areas), compliance with all applicable regulations and standards must be ensured.
- Once the drive has been installed, the fitter must mark the used tubular drive in the “Technical data” chapter and make a note of the installation position.



Caution

Safety instructions for avoiding serious injuries.

- **When electrical or electronic equipment and units are operated, certain components, e.g., the power supply unit, are live. Physical injuries or damage to property can result in the event of unauthorised interventions or failure to heed warnings.**
- **Be careful when touching the tubular drive, as it heats up during operation for technical reasons.**
- **Before installation, shut down all lines and control devices that are not essential for operation.**
- **Crushing or shearing points must be avoided or protected.**
- **When installing the drive, all-pole disconnection from the mains with a contact gap of at least 3 mm per pole must be provided (EN 60335).**
- **If the mains connecting cable is damaged, it may only be replaced by the manufacturer. If the drive has a plug-in connecting cable, it must be replaced with the same type of mains connecting cable, which is available from the drive manufacturer.**

Attention

Safety instructions for avoiding property damage.

- **Ensure that there is adequate clearance between moving parts and adjacent objects.**
- **The drive must not be carried by the mains connecting cable.**
- **All latching connections and fastening screws on the brackets must be checked to ensure that they are secure.**
- **Ensure that nothing rubs against the tubular drive, such as shading solution attachments, screws, etc.**
- **The drive must be fitted horizontally.**

Intended use

The type of tubular drive described in these instructions is intended solely for the operation of roller shutters.

This type of tubular drive supports not only curtain attachment by means of springs but also rigid shaft connectors. These are detected automatically.

If the springs or the top lath are screwed or riveted to the barrel, a point must be set in the lower limit position.

When mounting connection parts on the drive dia. 35 mm PXX/XX, only use screws EJOT Delta PT 40x12 WN 5454 Torx (9900 000 545 4).

For sun protection applications, please use only the types of tubular drive designed for this purpose.

This type of tubular drive is designed for use in single systems (one drive per barrel).

The tubular drive must not be used in potentially explosive areas.

The connecting cable is not suitable for transporting the drive. Always carry the drive by the housing tube.

Other applications, uses and modifications are not permitted in order to protect the safety of the users and others, since these actions can impair the system's safety and carry the risk of personal injury and property damage. The drive manufacturer does not accept liability for damages or injury arising from such actions.

Always observe the information in these instructions when operating or repairing the system. The drive manufacturer does not accept liability for damage or injury resulting from improper usage.

Attention

Only use rigid shaft connectors if the roller shutter laths are sufficiently strong. The closed curtain must not project beyond the guide tracks or else there is a risk of the joint between the top two laths being subjected to excessive strain and getting damaged.

Assembling and disassembling the plug-in connecting cable



Caution

The power supply to the connecting cable must be disconnected prior to assembly/disassembly.

Assembling the plug-in connecting cable

Ø35/Ø45/Ø58

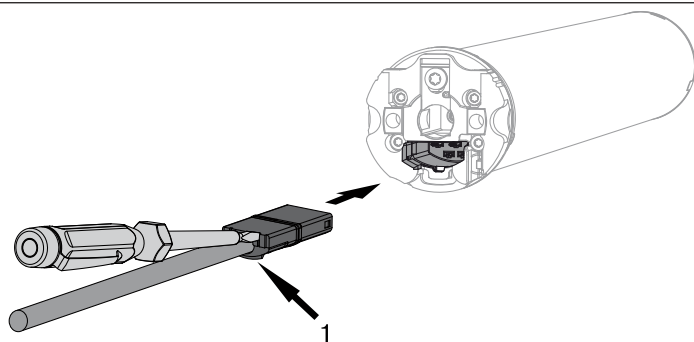

1 = locating lug

Insert the **dead** connecting cable into the drive head until the locating lug clicks into place in the drive. If necessary, use a suitable flathead screwdriver to assist with insertion. Set the screwdriver into one of the two plug grooves provided for this purpose.

Check that the cable is properly engaged.

Disassembling the plug-in connecting cable for tubular drives

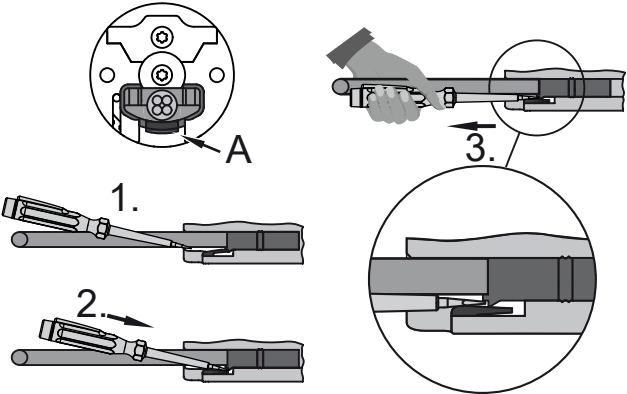
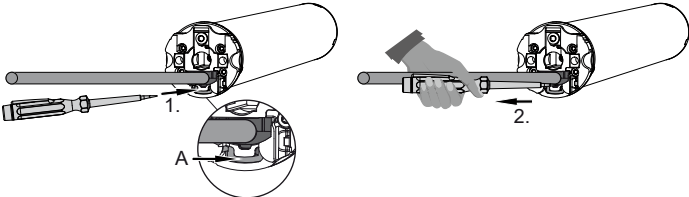
<p style="text-align: center;">Ø35</p> 	<p>Insert a suitable flathead screwdriver between the locating lug and the snap-in pin, so that the snap-in pin releases the locating lug from the plug.</p> <p>Now you can pull out the connecting cable along with the flat-head screwdriver.</p>
<p style="text-align: center;">Ø45/Ø58</p> 	<p>Insert a suitable flathead screwdriver right into the recess of the locating latch, so that the latch releases the locating lug from the plug.</p> <p>Now you can pull out the connecting cable along with the flat-head screwdriver.</p>
<p>A = snap-in pin</p>	
<p>A = locating latch</p>	

Assembly

Assembling the drive

Attention

To connect the drive to the driven part, solely mechanical accessory components made by the drive manufacturer from the current product catalogue may be used.

Prior to mounting, the fitter must ensure that the masonry and the system being motorised are sufficiently robust (drive torque plus weight of the shading solution).



Caution

Electrical connections may only be carried out by a qualified electrician. Prior to assembly, the power supply must be disconnected and secured. Please give the enclosed connection information to the responsible electrical contractor.

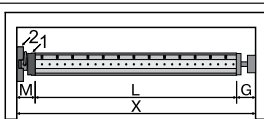

Calculate the space required at the side (M) by measuring the drive head (1) and wall bracket (2). The clear dimension of the box (X) minus the space required at the side (M) and idler (G) gives the length (L) of the barrel: $L = X - M - G$.

The space required at the side (M) varies depending on the combination of drive and wall bracket.

Then mount the wall bracket and idler. Ensure that the barrel is aligned at right angles to the wall and that sufficient axial play is allowed for the mounted system.

Attention

When using rigid shaft connectors, closed brackets must be fitted. The tubular drive presses the closed curtain down to make it difficult for people to reach under it or raise it. Only use curtains made of sufficiently strong material, such as aluminium, steel or wood. To prevent damage to the curtain it must run in guide tracks from top to bottom.

Assembling and disassembling the mounting pin

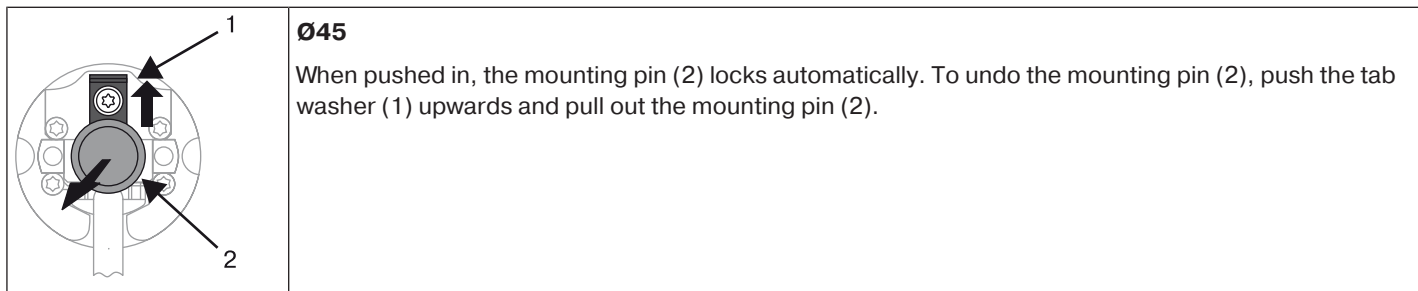

If you wish to use the "obstacle detection" function, you must use the "drive adapter for obstacle detection".

Assembling and disassembling the drive adapter

Fitting the ring onto the thrust ring

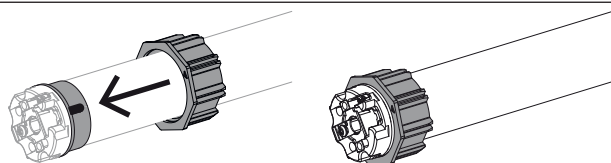

Assembling the drive adapter with safety catch on the drive shaft

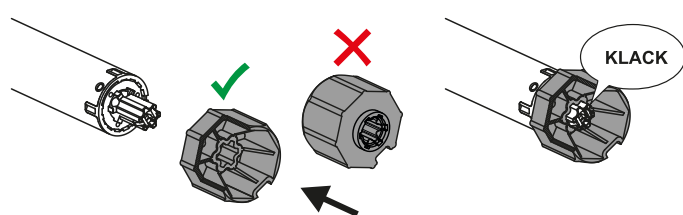

Disassembling the drive adapter with safety catch on the drive shaft

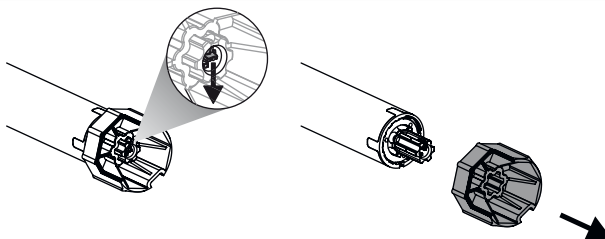

Assembling and disassembling the drive adapter with drive adapter safety catch or screw connection

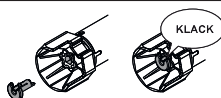

Assembling and disassembling the drive adapter with separate drive adapter safety catch

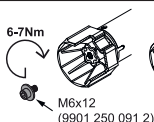

Assembling and disassembling the drive adapter with screw connection

Mounting the drive in the tube

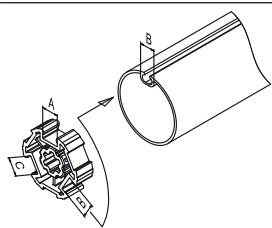

For profile shafts:

In the case of some drive adapters, tolerances of the groove widths in different barrels can be offset by rotating the drive adapter into a different groove recess. These groove recesses have different sizes and allow the drive to fit exactly.

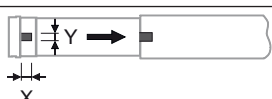

For round shafts:

Measure the lug of the thrust ring (X, Y). Then notch the tube on the motor side, so the lug of the thrust ring can also be pushed into the shaft. There must be no play between the lug of the thrust ring and the shaft.

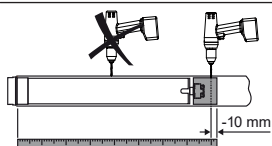

To ensure secure torque transmission for **round shafts**, we recommend screwing the drive adapter to the shaft (see the table below).

Attention! When drilling into the barrel, never drill near the tubular drive!

Size of drive [mm]	Drive adapter	Torque max. [Nm]	Fastening screws (4 units)
dia. 35-dia. 45	All	Up to 50	Self-tapping screw dia. 4.8 x 9.5 mm

We also recommend screwing the idler to the barrel.

Attention

Do not hammer the tubular drive into the tube or drop it into the barrel! The curtain can only be secured using springs or rigid shaft connectors. We recommend at least three pieces per metre of barrel.

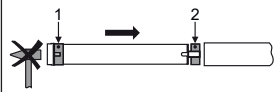

Assemble the tubular drive with the relevant ring (1) and drive adapter (2). If the ring has several grooves, select the groove which is a perfect fit and push the ring (1) onto the thrust ring.

Insert the tubular drive with the pre-assembled ring (1) and drive adapter (2) into the tube to achieve a form fit. Ensure that the ring and drive adapter are secure in the tube.

Mount the assembled unit comprising shaft, tubular drive and idler on the box and secure the drive with a splint or spring pin according to the type of wall bracket fixing.

Position the barrel so that the roller shutter curtain can be attached with springs or fit the rigid shaft connectors in accordance with the manufacturer's instructions.

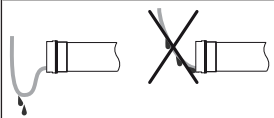

Lay the connecting cable

Lay the connecting cable up to the tubular drive, and fix. The connecting cable must not project into the winding chamber. The exterior antenna, if present, must not be shortened or damaged under any circumstances and must not project into the winding space. Cover any sharp edges.

Setting the limit positions with the switches on the drive head

Attention

The cord switch set is only designed for the commissioning, and not for continuous operation.

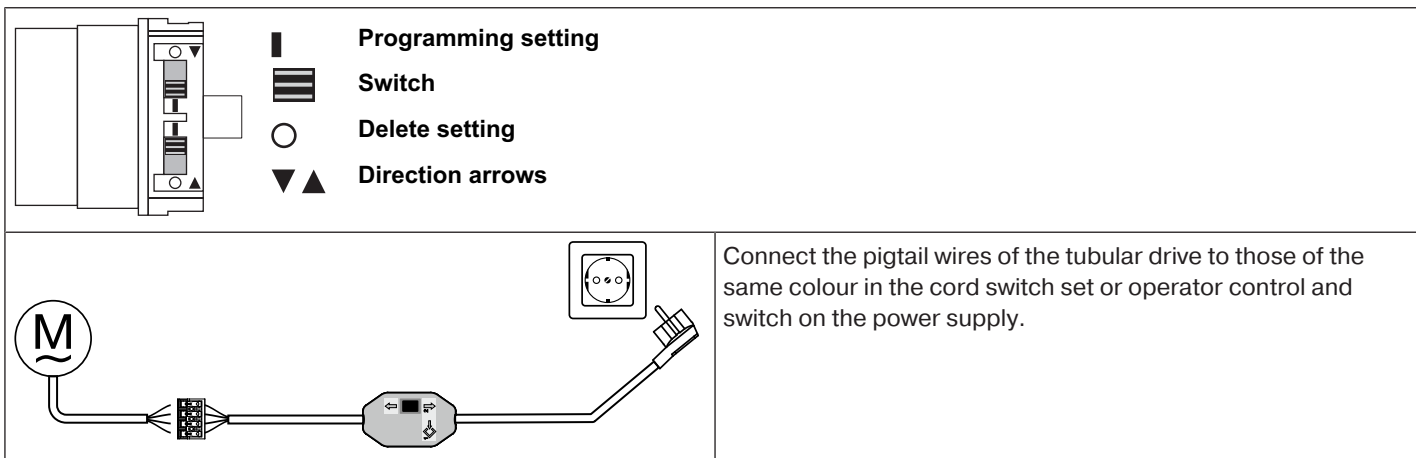

Intelligent installation management

Completion of installation following automatic setting of limit position "Stop"

Next time the "stop" limit position is travelled to, this position will be provisionally saved as the limit position. Once the limit position has been detected at this position 3 times in a row without any problems, it will be definitively saved. This normally takes place during regular operation.

To complete installation quickly, it is sufficient to travel to the "stop" limit position 3 times in a row from approx. 20 cm.

Limit position status indicator

A brief stopping and restarting indicates that no limit position has been set in that direction of movement.

Setting the limit positions

There are **3** ways to set the limit positions:

- Upper stop to lower stop
- Upper point to lower point
- Upper point to lower stop

The limit position becomes fixed after the tubular drive has turned off automatically in the desired position three times.



If the tubular drive switches off prematurely while opening or closing, due to an obstruction, the obstruction can be cleared by reversing a short way and removing the obstruction. The desired limit position can be set by opening/closing again.

When first installing using springs and adjusting the limit position "...to lower stop", the barrel in the lower limit position turns approx. 1/4 of a turn further than usual. In doing so, the tubular drive is able to automatically detect the use of rigid shaft connectors or springs. The tubular drive switches off automatically.

Upper stop to lower stop

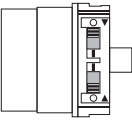
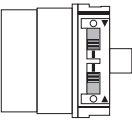
	Set both switches to the delete setting .
▲ / ▼ 1s	Execute a short drive command.
	Set both switches to the programming setting .
▲	Open to the permanent upper stop until the tubular drive switches off automatically.
▼	Then close to the permanent lower stop without pausing. During travel, the end position status indicator (ESI) must be displayed before the end position is reached. ▶ The limit positions are now set.

Upper point to lower point

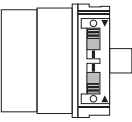
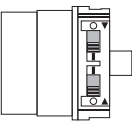
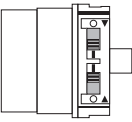

There is no shading solution length adjustment with this limit position setting.

	Set both switches to the delete setting .
▲ / ▼ 1s	Execute a short drive command.
▲	Open to the desired upper limit position.
	Now reset the switch of the UP direction of rotation from the delete setting to the programming setting.
▼	Then close to the desired lower limit position.
	Reset the switch of the DOWN direction of rotation from the delete setting to the programming setting. ▶ The limit positions are now set.

Upper point to lower stop

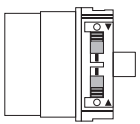
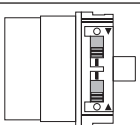

There is no shading solution length adjustment with this limit position setting.

	Set both switches to the delete setting .
▲ / ▼ 1s	Execute a short drive command.
▲	Open to the desired upper limit position.
	Now reset the switch of the UP direction of rotation from the delete setting to the programming setting.
▼	Then close to the permanent lower stop without pausing. During travel, the end position status indicator (ESI) must be displayed before the end position is reached. ► The limit positions are now set.

Deleting the limit positions using the switches

Deleting individual limit positions

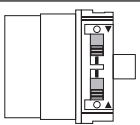

It is possible to delete an individual limit position, if lower point to upper point without stops has been programmed with the switches.

	Reset the switch of the corresponding limit position from the programming setting to the delete setting.
▲ / ▼ 1s	Execute a short drive command. ► The limit position is now deleted.

Deleting both limit positions

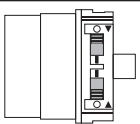
	Reset both switches from the programming setting to the delete setting.
▲ / ▼ 1s	Execute a short drive command. ► Both limit positions are deleted.

Setting the limit positions using the programming unit

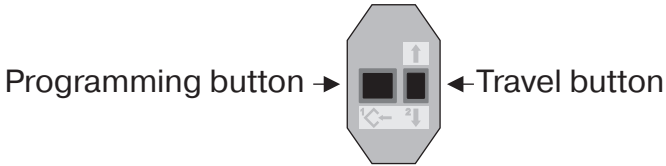
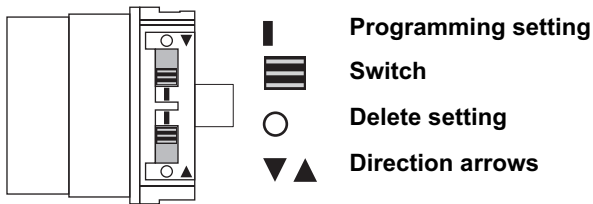

Connect the wires of the tubular drive to those of the same colour in the programming unit for drives with electronic limit switching and switch on the power supply.

Attention

The programming unit is only designed for the commissioning, not for continuous operation.

Intelligent installation management

Completion of installation following automatic setting of limit position "Stop"

Next time the "stop" limit position is travelled to, this position will be provisionally saved as the limit position. Once the limit position has been detected at this position 3 times in a row without any problems, it will be definitively saved. This normally takes place during regular operation.

To complete installation quickly, it is sufficient to travel to the "stop" limit position 3 times in a row from approx. 20 cm.

Limit position status indicator

A brief stopping and restarting indicates that no limit position has been set in that direction of movement.

Setting the limit positions

There are **4** ways to set the limit positions:

- Upper stop to lower stop
- Upper point to lower point
- Upper stop to lower point
- Upper point to lower stop



The limit position becomes fixed after the tubular drive has turned off **automatically** in the desired position three times.



If the tubular drive switches off prematurely while opening or closing, due to an obstruction, the obstruction can be cleared by reversing a short way and removing the obstruction. The desired limit position can be set by opening/closing again.

When first installing using springs and adjusting the limit position "...to lower stop", the barrel in the lower limit position turns approx. 1/4 of a turn further than usual. In doing so, the tubular drive is able to automatically detect the use of rigid shaft connectors or springs. The tubular drive switches off automatically.

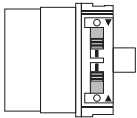



Upper stop to lower stop

	<p>Set both switches to the programming setting.</p>
	<p>Open as far as the permanent upper stop.</p> <ul style="list-style-type: none"> ▷ The tubular drive switches off automatically.
	<p>Then close to the permanent lower stop without pausing. During travel, the end position status indicator (ESI) must be displayed before the end position is reached.</p> <ul style="list-style-type: none"> ▷ The tubular drive switches off automatically. ▶ The limit positions are now set.



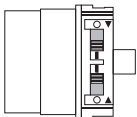

Upper point to lower point

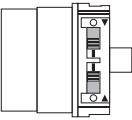

There is no shading solution length adjustment with this limit position setting.

	<p>Set both switches to the programming setting.</p>
	<p>Open to the desired upper limit position.</p>
	<p>(M) 1x</p> <p>Press the programming button of the programming unit for 3 seconds.</p> <ul style="list-style-type: none"> ▷ The tubular drive acknowledges.
	<p>Then close to the desired lower limit position.</p>
	<p>(M) 1x</p> <p>Press the programming button of the programming unit for 3 seconds.</p> <ul style="list-style-type: none"> ▷ The tubular drive acknowledges. ▶ The limit positions are now set.





Upper stop to lower point

		Set both switches to the programming setting.
		Open as far as the permanent upper stop. <ul style="list-style-type: none"> ▷ The tubular drive switches off automatically.
		Then close to the desired lower limit position.
	M 1x	Press the programming button of the programming unit for 3 seconds. <ul style="list-style-type: none"> ▷ The tubular drive acknowledges. ▶ The limit positions are now set.

Upper point to lower stop

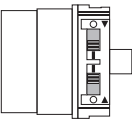

There is no shading solution length adjustment with this limit position setting.

		Set both switches to the programming setting.
		Open to the desired upper limit position.
	M 1x	Press the programming button of the programming unit for 3 seconds. <ul style="list-style-type: none"> ▷ The tubular drive acknowledges.
		Then close to the permanent lower stop without pausing. During travel, the end position status indicator (ESI) must be displayed before the end position is reached. <ul style="list-style-type: none"> ▷ The tubular drive switches off automatically. ▶ The limit positions are now set.







Deleting the limit positions using the programming unit



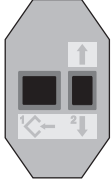
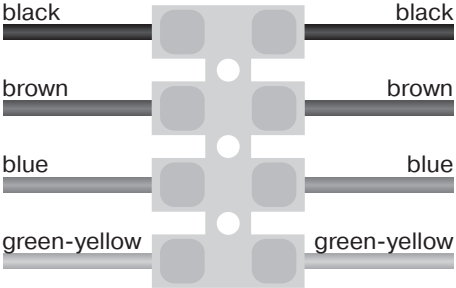



Connect the wires of the tubular drive to those of the same colour in the programming unit and switch on the power supply.

Please pause for 1 sec after the last drive command before beginning the deletion sequence. Also leave a pause of 1 sec between the individual steps of the deletion sequence.

Deleting a limit position when 2 limit positions are programmed

<div style="display: flex; justify-content: space-between; align-items: center;"> <div style="text-align: center;">  </div> <div style="text-align: center;">  </div> </div> <div style="text-align: center; margin-top: 10px;">  </div>	<div style="text-align: center; margin-bottom: 20px;">  </div>
	Open/close to the limit position to be deleted.
	Press the programming button and keep it pressed.
	Then press down the travel button and keep it pressed.
	Now release the programming button, but continue to keep the travel button pressed.
	Next press the programming button again. <ul style="list-style-type: none"> ▷ The tubular drive acknowledges. ▶ The limit position is now deleted.

Deleting both limit positions

		Open/close the shading solution to a point between the limit positions.
		Press the programming button and keep it pressed.
		Then press down the travel button and keep it pressed.
		Now release the programming button, but continue to keep the travel button pressed.
	M 2x	Next press the programming button again. <ul style="list-style-type: none"> ▶ The tubular drive acknowledges. ▶ Both limit positions are deleted.

Adjusting the limit positions with a rotary switch or a locking button



Intelligent installation management

Completion of installation following automatic setting of limit position "Stop"

Next time the "stop" limit position is travelled to, this position will be provisionally saved as the limit position. Once the limit position has been detected at this position 3 times in a row without any problems, it will be definitively saved. This normally takes place during regular operation.

To complete installation quickly, it is sufficient to travel to the "stop" limit position 3 times in a row from approx. 20 cm.

Limit position status indicator

A brief stopping and restarting indicates that no limit position has been set in that direction of movement.

There are 4 ways to set the limit positions:

- Upper stop to lower stop
- Upper point to lower point
- Upper stop to lower point
- Upper point to lower stop

The limit position becomes fixed after the tubular drive has turned off automatically in the desired position three times.

i **If the tubular drive switches off prematurely while opening or closing, due to an obstruction, the obstruction can be cleared by reversing a short way and removing the obstruction. The desired limit position can be set by opening/closing again.**
When first installing using springs and adjusting the limit position "...to lower stop", the barrel in the lower limit position turns approx. 1/4 of a turn further than usual. In doing so, the tubular drive is able to automatically detect the use of rigid shaft connectors or springs. The tubular drive switches off automatically.

Upper stop to lower stop

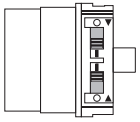
	Set both switches to the programming setting.
▲	Open to the permanent upper stop. ▷ The tubular drive switches off automatically.
▼	Then close to the permanent lower stop without pausing. During travel, the end position status indicator (ESI) must be displayed before the end position is reached. ▷ The tubular drive switches off automatically. ▶ The limit positions are now set.

Upper stop to lower point

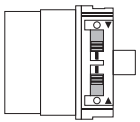
	Set both switches to the programming setting.
▲	Open to the permanent upper stop. ▷ The tubular drive switches off automatically.
▼	Then close to the desired lower limit position.
Carry out the following sequence without interruption between the individual drive commands. ▷ The tubular drive acknowledges.	
▲ 1 s ▲ 1 s ▼ until STOP and hold until	(M) 1x
The limit positions are now set.	

Upper point to lower stop

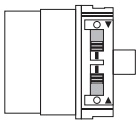

There is no shading solution length adjustment with this limit position setting.

	Set both switches to the programming setting.
▲	Open to the desired upper limit position.
Carry out the following sequence without interruption between the individual drive commands. ▷ The tubular drive acknowledges.	
▼ 1 s ▼ 1 s ▲ until STOP and hold until	(M) 1x
▼	Then close to the permanent lower stop without pausing. During travel, the end position status indicator (ESI) must be displayed before the end position is reached. ▷ The tubular drive switches off automatically.
The limit positions are now set.	

Upper point to lower point



There is no shading solution length adjustment with this limit position setting.

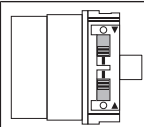

Set both switches to the programming setting.



Open to the desired upper limit position.

Carry out the following sequence without interruption between the individual drive commands.

▷ The tubular drive acknowledges.



1 s

1 s

until STOP and hold until

(M) 1x



Then close to the desired lower limit position.

Carry out the following sequence without interruption between the individual drive commands.

▷ The tubular drive acknowledges.



1 s

1 s

until STOP and hold until

(M) 1x

The limit positions are now set.

Deleting the limit positions with a rotary switch or a locking button



The switching commands sequence must be carried out in quick succession.

Carry out the following deletion sequence without interruption between the individual drive commands:



1 s

1 s

1 s

1 s

1 s

1 s

1 s

until

(M) 2x



STOP

The tubular drive acknowledges.
Both limit positions are deleted.

Additional upper anti-freeze mechanism



The upper anti-freeze mechanism helps to prevent the roller shutter from freezing in the upper limit position, as the roller shutter stops just before the upper stop. The distance from the upper stop is automatically cyclically checked and, if necessary, corrected.

Both limit positions must be set before the anti-freeze mechanism can be activated.

i **The anti-freeze mechanism only works if a permanent stop is set at the upper limit position of the roller shutter. The anti-freeze mechanism is not visible until the shading solution has reached the upper stop from the lower limit position 3 times in succession. When the limit positions are deleted with the programming unit, this set function is reset to the factory setting.**

This function is deactivated on delivery.

Activating/deactivating the upper anti-freeze mechanism

		Open/close the shading solution to a point between the limit positions.
 10s		Press the programming button on the programming unit for approx. 10 seconds. ► The tubular drive confirms.

Obstacle detection

Caution
Obstacle detection is only active in conjunction with the "drive adapter for obstacle detection".
In addition, please note that the drive must be pushed in to the shaft as far as the band of the thrust ring.
Use of the drive's obstacle detection system as personal protection is not permitted. It has been designed exclusively to protect the roller shutters or sun protection system from being damaged.

If the drive is correctly installed, it switches off when it detects obstructions or shutter faults and reverses a short way in the opposite direction and thus away from the obstacle.

If reversing is interrupted, a further drive command is only possible in the direction of reversing. Travel the shading solution without interruption until the tubular drive stops automatically. It is now possible to travel in both directions again.

The following are detected:

Moving DOWN

- A curtain jam when closing due to objects on the window sill or sticking of the lateral guide tracks.

i **If the tubular drive switches off in the area of the upper limit position, it checks once more whether an obstacle is present.**

To ensure complete closing of the roller shutter curtain at the lower limit position, the curtain does not reverse once it gets to approx. 360° from the lower limit position.

To ensure that the roller shutter curtain safely enters the guide tracks, obstacle detection is inactive for approx. 1.5 revolutions of the barrel from the upper limit position.

Moving UP

- Extremely large increase in the load (e.g., ice on the end strip)





Fly screen protection function

If the fly screen protection function is activated, obstacle detection is activated after a revolution of the barrel of approx. 140° from the upper limit position. If the roller shutter curtain meets an opened fly screen door, the drive stops and returns to the upper limit position.

This function is deactivated on delivery.

Both limit positions must be set before the fly screen protection function can be activated.

Activating/Deactivating the fly screen protection function

		Open the shading solution to the upper limit position.
 		Now press the travel button downwards and within 1 second press the programming button too. The tubular drive acknowledges.

Information for the electrician

Tubular drives with electronic limit switching can be connected in parallel. The maximum switching contact load of the switching equipment (timer, relay control, switch, etc.) must be observed. To operate drives with electronic limit switching, only use switching elements (timers) that are **not** earthed via the drive. The outputs of the switching element must be potential-free in the neutral position.

Use external conductor L1 to control the up and down direction. Other devices or consumers (lamps, relays, etc.) must not be directly connected to the drive connecting cables. For this purpose, the drives and additional devices must be decoupled by relay controls.

When installing the drive, all-pole disconnection from the mains with a contact gap of at least 3 mm per pole must be provided.

Attention

Only use mechanically or electrically locked switching elements with a marked zero position! This also applies when drives with electronic and mechanical limit switching are used in the same system. The changeover time for switching the running direction must be at least 0.5 s. The switch and control must not execute simultaneous UP and DOWN commands. Protect the electrical connections from damp.

Once you have finished wiring everything to the control, ALWAYS check the right direction assignment of the drive to the control buttons UP and DOWN, EXTEND and RETRACT.

If the drive is to be operated with devices which contain sources of interference, the electrician must ensure suitable interference suppression for the relevant devices.

Torque detection

A correctly installed tubular drive reacts to extraordinarily large increases in load during operation between the limit positions and thereby prevents an overload of the tubular drive.

Disposal



The crossed-out bin symbol on the product indicates that the device is subject to mandatory disposal separate from household waste. This product must be handed over to a collection point for electrical and electronic equipment at the end of its service life. The packaging material must be disposed of properly.

Maintenance

These drives are maintenance-free.

Technical data dia. 35

Tubular drive	P5-16	P9-16
Model	E01	
Type	CPRO+	
Rated torque [Nm]	5	9
Output speed [rpm]	16	16
Limit switch range	64 revolutions	
Supply voltage	230 V AC / 50 Hz	
Connected load [W]	85	110
Rated current consumption [A]	0.36	0.47
Mode	S2 4 min	
Degree of protection	IP 44	
Min. tube inside diameter [mm]	37	
Emission sound pressure level [dB(A)]	≤ 70	

Technical data dia. 45

Tubular drive	R8-17	R12-17	R20-17	R30-17	R40-17
Model	E01				
Type	CPRO+				
Rated torque [Nm]	8	12	20	30	40
Output speed [rpm]	17				
Limit switch range	64 revolutions				
Supply voltage	230 V AC / 50 Hz				
Connected load [W]	100	110	160	205	260
Rated current consumption [A]	0.45	0.50	0.75	0.90	1.15
Mode	S2 4 min				
Degree of protection	IP 44				
Min. tube inside diameter [mm]	47				
Emission sound pressure level [dB(A)]	≤ 70				

What to do if...?

Problem	Remedy
The roller shutter curtain is raised unevenly or not at all.	Stops have broken off or one or several attachments are broken. Repair system; delete limit positions, then reprogram limit positions.
Tubular drive overruns the limit position or does not reach the set limit position.	Repair system; delete limit positions, then reprogram limit positions.
	Check electrical installation, remove external devices, delete limit positions and then reset limit positions.
Tubular drive stops arbitrarily; cannot be restarted in the same direction.	Tubular drive has detected an increase in load. Briefly run the curtain in the opposite direction, then continue in the desired direction.
	Tubular drive is overloaded. Use a higher-torque tubular drive.
	Delete limit positions, then reprogram limit positions.
Tubular drive does not run in the right direction.	Tubular drive is overheated. The tubular drive is operational again after a few minutes.
	Tubular drive is faulty (does not run even after standing still for a long period of time). Replace the tubular drive.
	Clear and remove the obstruction and set the drive in the direction required.
	Check the electrical connection.
Setting the limit positions using the programming unit does not work.	Set both switches to the delete setting. Execute a short drive command. Set both switches to the programming setting simultaneously. Re-set the limit positions using the programming unit.
Setting the limit positions using the switch does not work.	Set both switches to the delete setting. Execute a short drive command. Re-set the limit positions.
During the programming run, the drive stops short of the limit position to be programmed.	For safety reasons, the drive reacts sensitively to sluggishness during the programming run, in order to prevent damage. Briefly run curtain DOWN and subsequently UP until you reach the upper limit position.
Ventilation slots of the roller shutter do not close fully.	Delete the limit positions (see Deleting limit positions) and then set the limit positions as per "to lower point" (see chapter Setting the limit positions); in this case, set the lower limit position first (lower point) followed by the upper limit position.

Sample wiring diagrams



The assignment of the black and brown wires according to the direction of travel is dependant on how the drive is installed (mounted to the right or to the left).

Controlling one/several drive(s) via a single switch/button

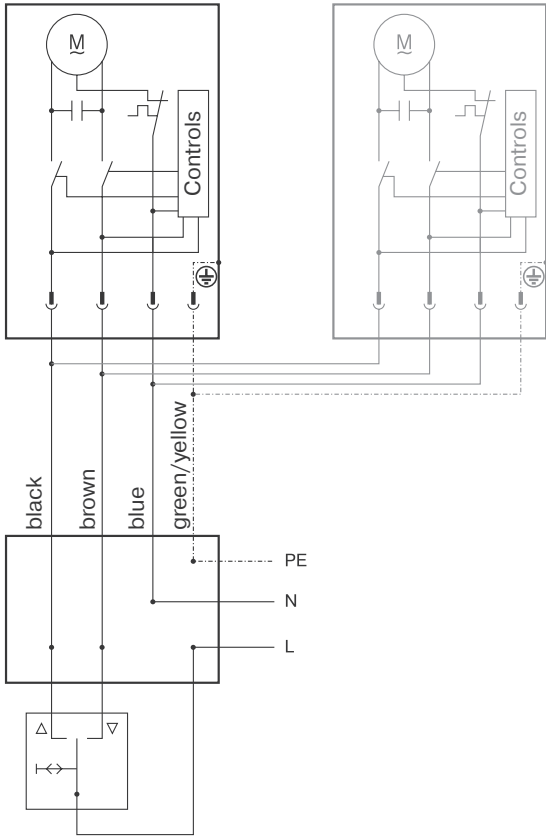

Central, group and individual control using Centronic UnitControl UC42

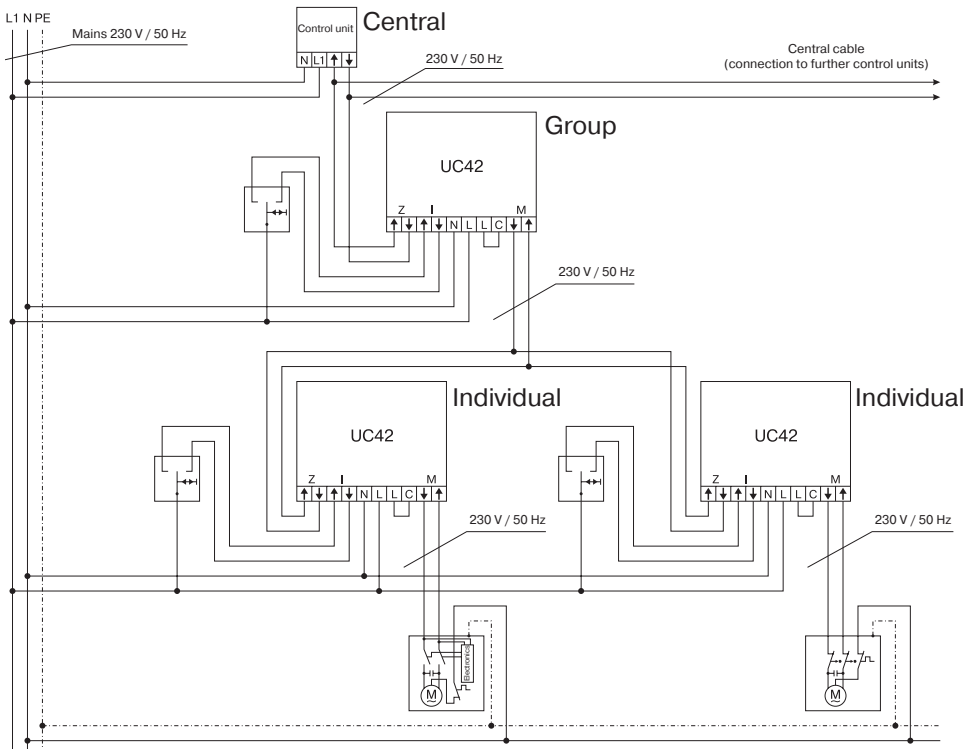

Declaration of conformity

BECKER-ANTRIEBE GMBH
Friedrich-Ebert-Str. 2 – 4
35764 Sinn, Germany



BECKER

- Original -

EU Declaration of Conformity

Document No.: **5100 310 005 0**

We hereby declare that the following product series

Product designation: **Tubular motor**

Type designation: **P3/30.., P4/16.., P4/17.., P5/16.., P5/30.., P5/20.., P9/16.., P13/9.., R4/17.., R7/17.., R7/85.., R8/17.., R12/11.., R12/17.., R15/17.., R20/11.., R20/17.., R25/17.., R30/11.., R30/17.., R40/11.., R40/17.., R50/3,5.., R50/11.., L44/14.., L50/11.., L50/17.., L60/11.., L60/17.., L70/17.., L80/11.., L80/17.., L100/11.., L120/11..**

Version: **C, EVO, M, HK, R, S, F, P, E, O, SMI, A0...Z9, mute, +**

From serial number: **from 232300001**

complies with the applicable regulations of the following Directives:

Directive 2006/42/EC (MD) L157, 09.06.2006

Directive 2014/30/EU (EMC) L96, 29.03.2014

Directive 2011/65/EU (RoHS) L174, 01.07.2011

Furthermore, the safety objectives of the **Low Voltage Directive 2014/35/EU** as per Appendix I No.1.5.1 of Directive 2006/42/EC have been met.

Applied standards:

DIN EN 60335-1:2020

DIN EN 60335-2-97:2017

EN 61000-6-1:2019

EN 61000-6-3:2022

EN 14202:2004

Authorised party for the compilation of the technical documentation:

Becker-Antriebe GmbH, Friedrich-Ebert-Str. 2 – 4, 35764 Sinn, Germany

This declaration of conformity was issued:

Sinn, 02.06.2023

Place, Date

Maik Wiegemann, Management

This declaration certifies compliance with the Directives cited but does not represent any assurance of characteristics. The safety warnings in the supplied product documentation must be observed!

CE Antriebe M+E_ 5100 310 005 0 _de

For UK-Markets:

The Declaration of Conformity can be provided upon request from Becker Motors Ltd., or can be downloaded on www.beckermotors.co.uk.

**UK
CA**



BECKER

25 - en

Initial setup - tubular drive - Type E01

Mechanical End Limit Position

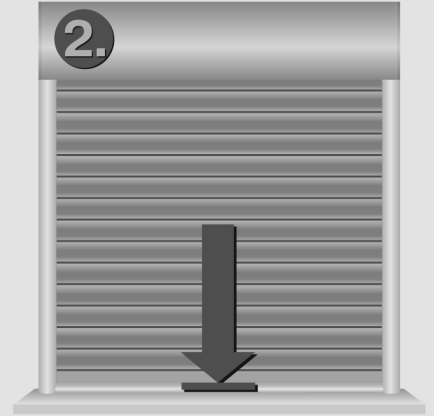
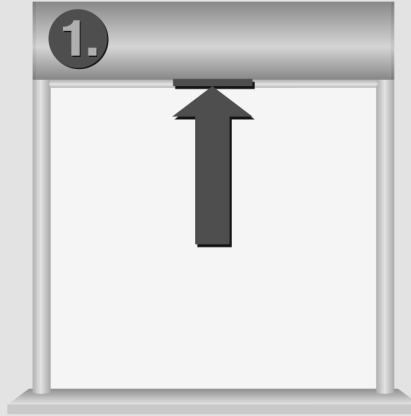
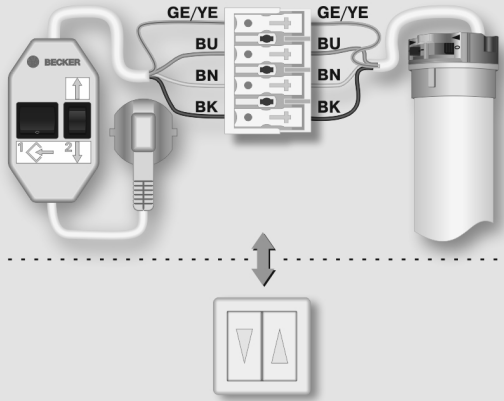

End Limit Point

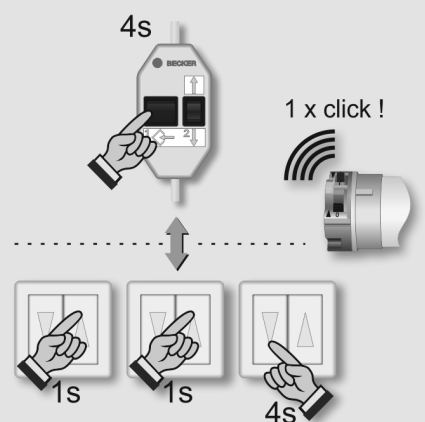
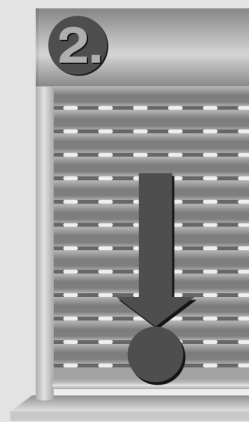
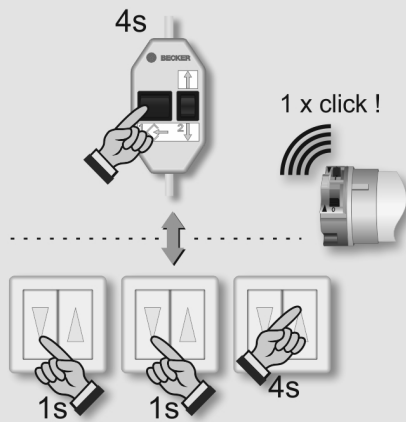
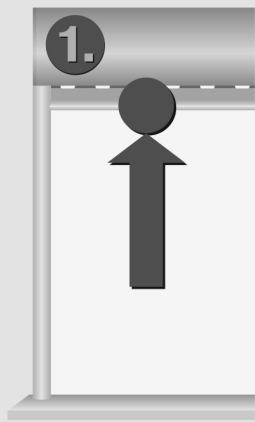

Deleting End Limit Position

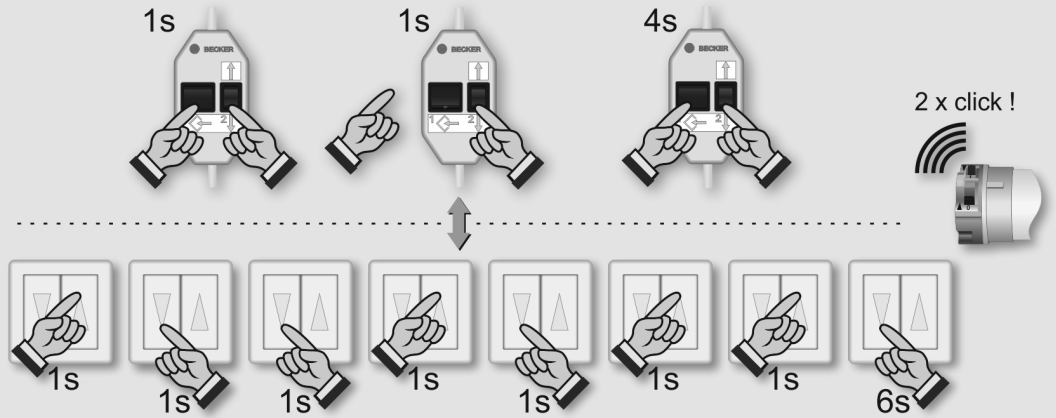
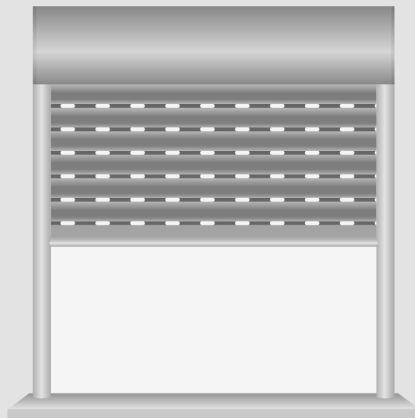

Upper anti-freeze mechanism

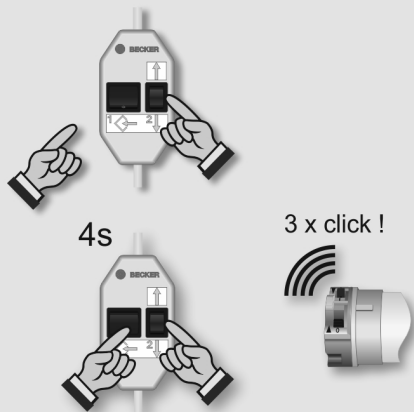

Fly screen protection function

